



THE 1

THE BMW 1 SERIES.



18 Highlights



20 Worlds of colour



24 Wheels and tyres / BMW M Performance Parts

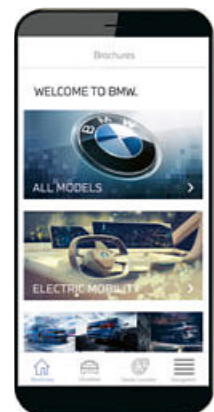

YOUR NEW SPEED DATING APP.

DOWNLOAD NOW THE BMW BROCHURES APP FROM YOUR APP STORE AND DISCOVER DRIVING PLEASURE!

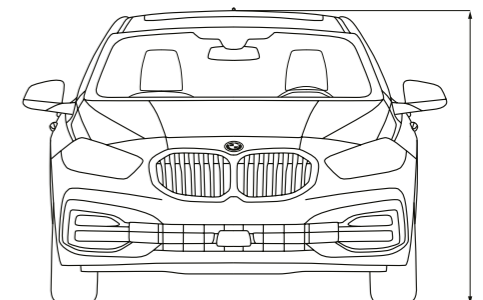

26 Technical data



EYE CANDY TO GO.



TURN YOUR BACK ON BORING.

LOOK, BUT PLEASE TOUCH.





YOU MIGHT WANT TO SIT DOWN FOR THIS.



CONNECTIONS
ARE
EVERYTHING.



TAKE THE LONG
WAY HOME – THEY’LL
UNDERSTAND.
THE BMW 1 SERIES.



HIGHLIGHTS.

Discover even more with the new BMW Brochures app. Available now, for your smartphone and tablet.

■ Standard equipment □ Optional equipment



□ The M Sport package gives the vehicle an even sportier touch. In addition to an appearance sharpened by many details in the exterior and interior, the M sports package guarantees an increase in driving pleasure. The M Sport suspension and the M Aerodynamics package for example noticeably optimise the driving dynamics.



□ The M sports seats* with integrated headrests, deep sitting surface and high side and backrest bolsters offer the driver and front passenger improved support, even in fast turns. In addition, the seat can be adjusted to your individual body size thanks to the integrated backrest width adjustment.



■ Its striking appearance and technical details make the BMW 128ti a particularly sporty representative of the model range. Matching its striking model-specific design elements, its petrol engine with BMW TwinPower Turbo technology and the differential lock on the front axle ensure driving dynamics of the highest standard.



□ When open, the Panorama glass roof provides a great deal of fresh air. Closed, it creates a bright, light-flooded atmosphere in the interior. It opens and closes completely automatically at the push of a button or with the vehicle key and is equipped with slide and lift functions, a roller sunblind and wind deflector.



□ The BMW Live Cockpit Professional with navigation function includes two high-quality displays consisting of a high-resolution 10.25" Control Display that can be operated by touch and a fully digital 10.25" instrument display. The BMW Operating System 7 can also be operated via the iDrive Touch Controller.

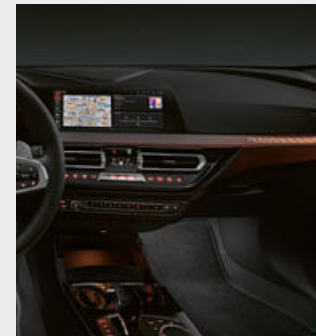

□ Interior trim finishes 'Illuminated Boston' with 'Mesh' accent on the instrument panel and door panel.*



□ The M Sport suspension is set approximately 10 mm lower and features more athletic settings.



□ Adaptive LED headlights with low-beam and high-beam headlights include LED turn indicators and Adaptive headlights.



□ Complementary to the iDrive Touch Controller, BMW Gesture Control* allows for specified functions to be controlled with gestures.



□ Your vehicle key? No need for that anymore. The Digital Key¹* exists on your smartphone, and you can share it with friends.



□ The large, full-colour BMW Head-Up Display²* projects information relevant to the journey directly into the driver's field of vision.

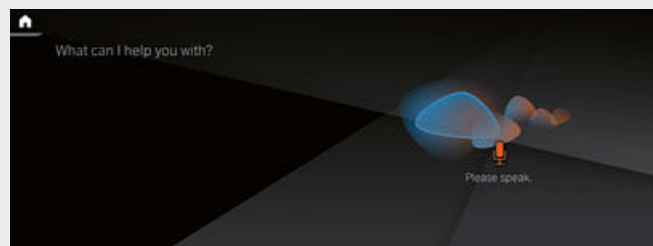

□ The BMW Intelligent Personal Assistant* is the very soul of your BMW, ready to help you at all times. To speak with the assistant, there is no need to activate it by pressing a button. Simply start talking as you normally would. You might say, for example, "Hello, BMW. Who are you?" Perhaps you would like to give the assistant a different name? If so, say, "Hey, BMW. Change the activation word."

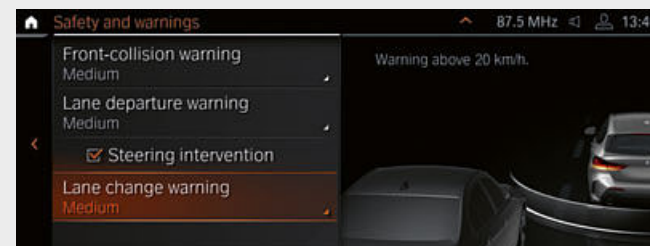

□ The safety package Driving Assistant³* includes the camera-based systems front collision warning with braking function, Speed Limit Assist incl. Speed Limit Info with No-overtaking indicator with preview and Lane Departure Warning. Additionally, the radar-based equipment includes Crossing traffic warning rear, Lane Change Warning and Rear collision warning.

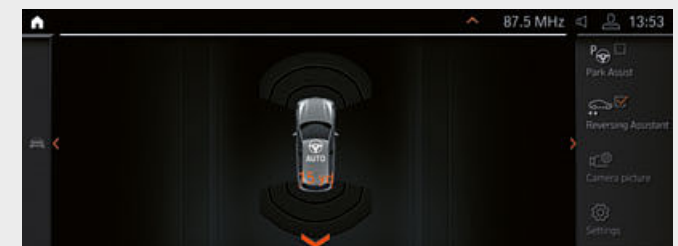

□ The Reversing Assistant* stores the last 50 m of the driven path in forward travel up to 35 km/h, so that it can be retracted if required. You are relieved of the steering work and can concentrate on monitoring the vehicle environment.

¹ Prerequisite is a BMW ConnectedDrive account and a compatible smartphone. For customers with a non-compatible smartphone, a high-quality Key Card is provided. More information about the BMW Digital Key, e.g. regarding the compatibility of your smartphone, is available at www.bmw.com/digitalkey

² The information in the BMW Head-Up Display is not fully visible when viewed through polarised sunglasses. Content shown will depend on the equipment options chosen. Further optional equipment is required to display specific items.

³ Function may be limited in darkness, fog or bright glare.

* The availability of some equipment features and functions depends on engine variants or additional options. The market and production availability may vary. You can find detailed information about terms, standard and optional equipment at www.bmw.com or at your BMW Partner.

Some ConnectedDrive Services may differ between countries. Please consult your local BMW partner for more information.

EXTERIOR COLOURS.

Discover even more with the new BMW Brochures app. Available now, for your smartphone and tablet.

■ Standard equipment □ Optional equipment



□ Non-metallic 300 Alpine White¹



■ Non-metallic 668 Black²



□ Metallic A96 Mineral White²

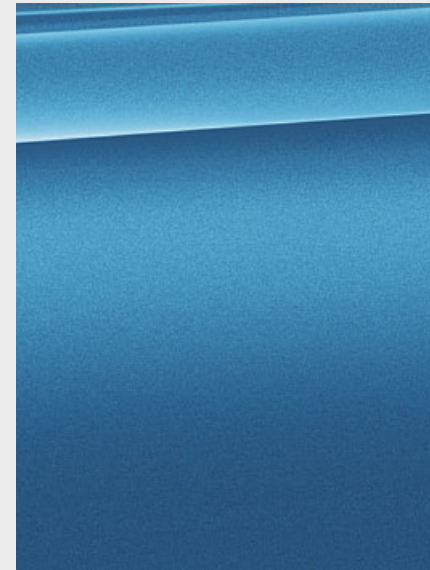

□ Metallic C1R Seaside Blue²

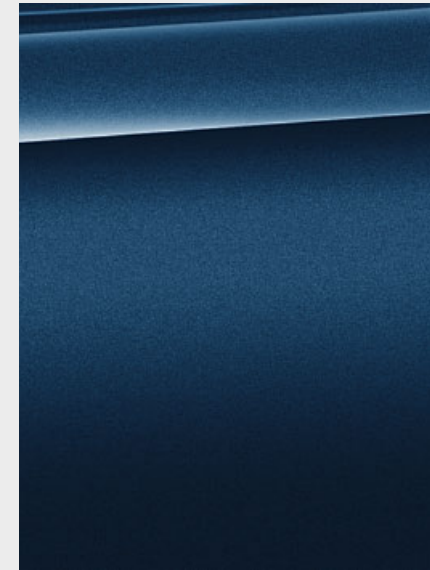

□ Metallic C1M Phytomic Blue²

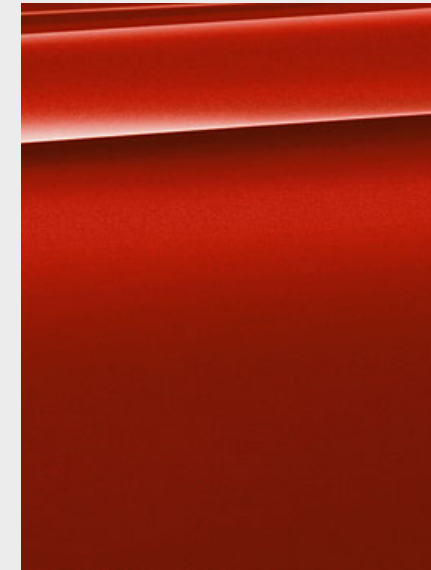

□ Metallic A75 Melbourne Red³



□ Metallic A83 Glacier Silver²

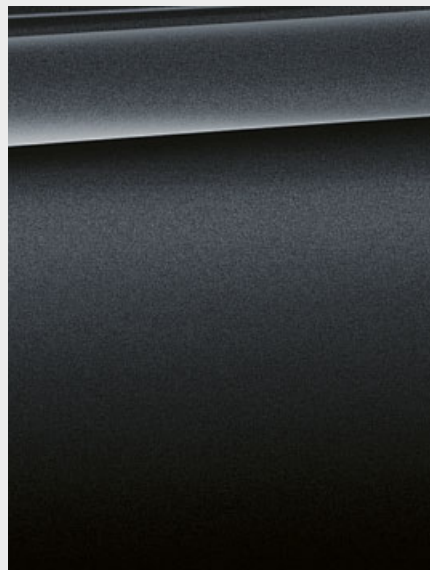

□ Metallic B39 Mineral Grey³

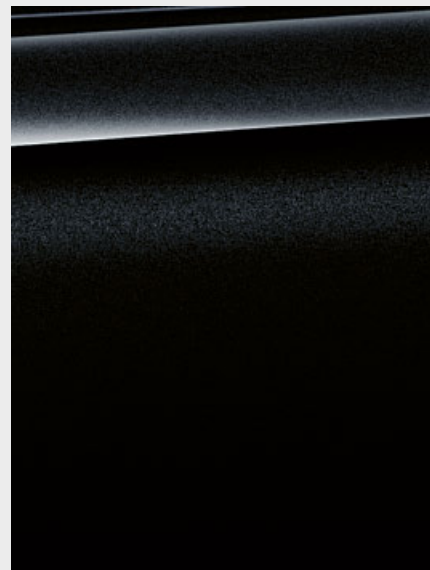

□ Metallic 475 Black Sapphire³

M SPORT PACKAGE

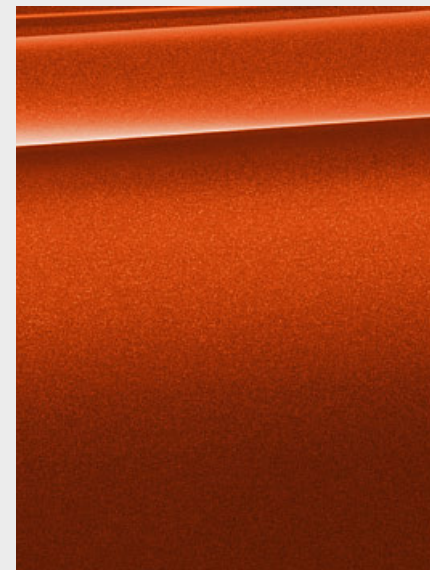

□ Metallic C1X Sunset Orange²



□ Metallic C1D M Misano Blue metallic⁴

BMW INDIVIDUAL

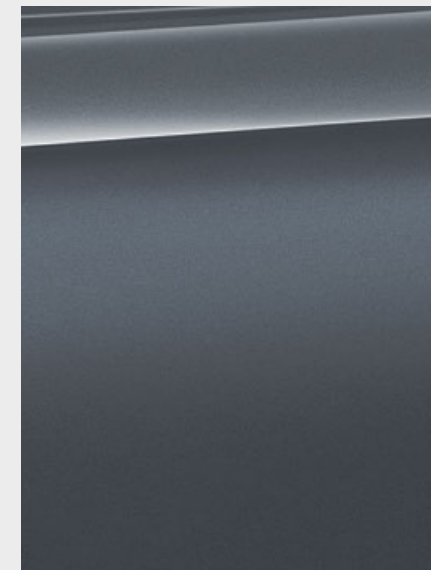

□ BMW Individual C3N Storm Bay metallic³

[Colour samples] These colour samples are intended as an initial guide to the colours and materials available for your BMW. However, experience has shown that printed versions of paint, upholstery and interior trim colours cannot in all cases faithfully reproduce the

appearance of the original colour. Please discuss your preferred colour choices with your BMW partner or in your dealership. There you can also see original samples and be assisted with special requests.

¹ Available as standard with the M Sport package and M135i xDrive.
² Not available with the M Sport package and M135i xDrive.
³ Optionally also available with the M Sport package and M135i xDrive.
⁴ Exclusively available with the M Sport package and M135i xDrive.

The availability of some equipment features and functions depends on engine variants or additional options. The market and production availability may vary. You can find detailed information about terms, standard and optional equipment at www.bmw.com or at your BMW Partner.

INTERIOR COLOURS.

Discover even more with the new BMW Brochures app. Available now, for your smartphone and tablet.

■ Standard equipment □ Optional equipment

CLOTH

Available with



■ Base

Cloth 'Grid' EGAT Anthracite*

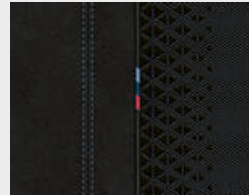

■ M Sport package

Cloth 'Trigon' HLSW Alcantara Black, Blue highlight*

LEATHER

Available with



□ Base
■ Luxury Line
□ Sport Line
□ M Sport package

Leather 'Dakota' PDSW with perforations Black



□ M Sport package

Leather 'Dakota' PDN4 with perforations Black, Blue highlight

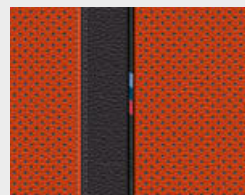

□ Base
■ Luxury Line
□ Sport Line
□ M Sport package

Leather Dakota PDFM with perforations Magma Red, Grey highlight*

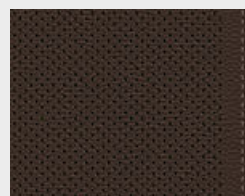

□ Base
■ Luxury Line
□ Sport Line
□ M Sport package

Leather 'Dakota' PDMY with perforations Mocha*

CLOTH-SENSATEC COMBINATION

Available with

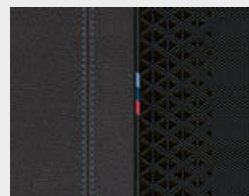

■ M Sport package

Cloth 'Trigon' KKSWSensatec Black*

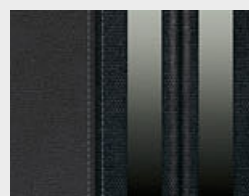

□ Base
■ Sport Line

Cloth/Sensatec combination KFL1 Anthracite, accent Grey*

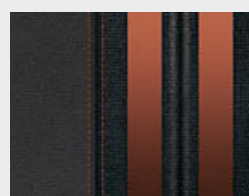

■ Sport Line

Cloth/Sensatec combination KFIX Anthracite, accent Orange

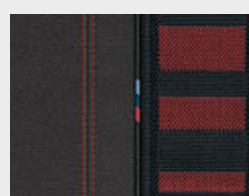

□ Base
■ Sport Line

Cloth/Sensatec combination KFL3 Black, accent Red*¹

INTERIOR TRIM FINISHERS

Available with

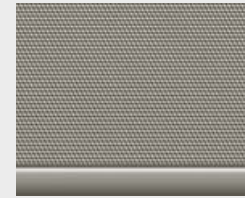

■ Base

Interior trim finishers Quartz Silver matt, grained.*

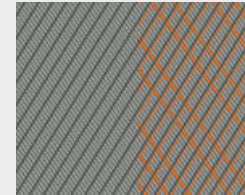

■ Luxury Line
■ Sport Line
■ M Sport package

Interior trim finishers 'Illuminated Boston' with 'Mesh' accent on the instrument panel and door panel.

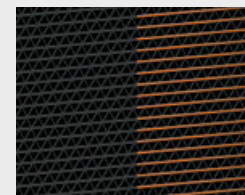

□ Base
■ Luxury Line
□ Sport Line
■ M Sport package

Interior trim finishers 'Illuminated Berlin' with 'High Matt' accent on the instrument panel and door panel.

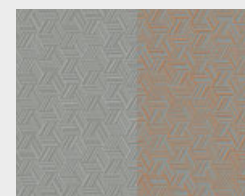

□ Base
■ Luxury Line
□ Sport Line
■ M Sport package

Interior trim finishers 'Illuminated Nice' with 'Hexanja' accent on the instrument panel and door panel.

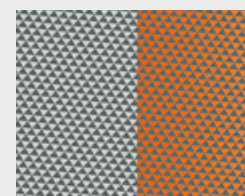

□ Base
■ Luxury Line
■ Sport Line
■ M Sport package

Interior trim finishers 'Illuminated Brooklyn' with 'Triangle' accent on the instrument panel and door panel.

M HEADLINER

Available with

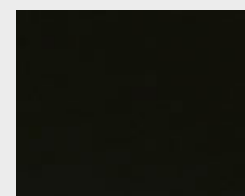

□ Base
□ Luxury Line
□ Sport Line
■ M Sport package

M anthracite headliner: Headliner and body pillar trim panels feature Anthracite cloth.

¹ Exclusively available for 128ti. Please note that even normal long- or short-term use can lead to unrecoverable

upholstery damage. This can be caused in particular by non-colourfast clothing. Please note that the interior colour depends on the selected upholstery colour.

* The availability of some equipment features and functions depends on engine variants or additional options. The market and production availability may vary. You can find detailed

information about terms, standard and optional equipment at www.bmw.com or at your BMW Partner.

WHEELS AND TYRES.

Discover even more with the new BMW Brochures app. Available now, for your smartphone and tablet.



□ 17" light alloy wheels
Multi-spoke style 546 Reflex
Silver metallic, gloss-lathed,
wheel size 7.5J x 17 with
225/45 R17 tyres.*



□ 17" light alloy wheels
Multi-spoke style 547 Ferric
Grey metallic, gloss-lathed,
wheel size 7.5J x 17 with
225/45 R17 tyres.¹



□ 17" light alloy wheels
Double-spoke style 548 Bicolour
Orbit Grey metallic, gloss-lathed,
7.5J x 17 with 225/45 R17 tyres.



□ 17" light alloy wheels
Double-spoke style 549 Orbit
Grey metallic, gloss-lathed,
7.5J x 17 with 225/45 R17
tyres.²



□ 17" M light alloy wheels
Double-spoke style 550 M
Bicolour Ferric Grey metallic,
gloss-lathed, wheel size
7.5J x 17 with 225/45 R17
tyres.³



□ 18" light alloy wheels
Multi-spoke style 488 Bicolour
Orbit Grey metallic, gloss-lathed,
wheel size 8J x 18 with 225/40
R18 tyres.*



□ 18" M light alloy wheels
V-spoke style 554 M Orbit
Grey metallic, 8J x 18 with
225/40 R18 tyres.⁵



■ 18" M light alloy wheels
Double-spoke style 556 M
Bicolour Cerium Grey matt,
gloss-lathed, wheel size
8J x 18 with 225/40 R18 tyres.⁴



□ 18" M light alloy wheels
Double-spoke style 819 M
Bicolour Orbit Grey metallic,
gloss-lathed, wheel size
8J x 18 with 225/40 R18 tyres.³



□ 18" M light alloy wheels
Y-spoke style 553 M Bicolour
Orbit Grey metallic with
performance tyres, gloss-lathed,
wheel size 8J x 18 with
225/40 R18 tyres.^{6*}



□ 19" M light alloy wheels
Double-spoke style 552 M
Bicolour Jet Black, gloss-lathed,
wheel size 8J x 19 with
235/35 R19 tyres.^{5*}



□ 19" M light alloy wheels
V-spoke style 557 M Bicolour
Cerium Grey metallic, wheel
size 8J x 19 with 235/35 R19
tyres.⁴

BMW M PERFORMANCE PARTS.

Equipment 24 | 25

■ Standard equipment □ Optional equipment ○ Accessories



M PERFORMANCE PARTS



○ Moving design. The M Performance roof spoiler is made of PUR in Black high-gloss, an elegantly athletic accent for the rear of the vehicle. At the same time, it contributes to optimised aerodynamics. The spoiler is perfectly tailored to the vehicle design and can be painted in the body colour.



○ The striking exterior mirror cap in a new, unique carbon-fibre look underlines the vehicle's high-tech character, adding an individual athletic touch.



○ Gripping facts: The steering wheel with Alcantara-lined grip area provides excellent feel and grip for a sportier steering feel.



○ For a shiny, athletic look: The M Performance front splitter in black high-gloss provides optimum aerodynamics and highlights the vehicle's masculine appearance in a highly exclusive manner. A unique motorsport look for anybody who refuses to compromise.



○ The rear diffuser with new carbon-fibre look creates an even more modern appearance – and makes the vehicle's sporty look even more impressive.



○ Weight-optimised 19" M Performance light alloy wheels Double-spoke style 555 M in Bicolor Jet Black matt, gloss-lathed. TPMS summer complete wheel set.

¹ Only available in conjunction with Luxury Line.

² Only available in conjunction with Sport Line.

³ Only available in conjunction with M Sport package.

⁴ Exclusively available for M135i xDrive.

⁵ Only available in conjunction with M Sport package and M135i xDrive.

⁶ Exclusively available for 128ti.

*The availability of some equipment features and functions depends on engine variants or additional options. The market and production availability may vary. You can find detailed information about terms, standard and optional equipment at www.bmw.com or at your BMW Partner.

Discover the wide range of innovative solutions available for the exterior and interior, communication and information, and for transportation and the luggage compartment. Your BMW Partner is on hand to advise you on the whole range

of Original BMW Accessories and the BMW M Performance Parts product portfolio. For further information, please visit www.bmw.com

BMW 1 Series		116i	118i	120i	128ti	M135i xDrive	116d	118d	120d 120d xDrive
--------------	--	------	------	------	-------	--------------	------	------	---------------------

Weight									
Unladen weight EU (xDrive) ¹	kg	1395 [1415]	1365 [1395]	[1465]	[1520]	[(1600)]	1450 [1460]	1480 [1505]	[1525] [(1590)]
Max. permissible weight (xDrive)	kg	1850 [1870]	1845 [1870]	[1920]	[2000]	[(2085)]	1925 [1940]	1950 [1980]	[2000] [(2065)]
Permitted load (xDrive)	kg	530 [530]	555 [550]	[530]	[555]	[(560)]	550 [555]	545 [550]	[550] [(550)]
Permitted trailer load, unbraked (xDrive) ²	kg	695 [705]	680 [695]	[730]	-	-	725 [730]	740 [750]	[750] [(750)]
Permitted trailer load, braked, max. 12% gradient/max. 8% gradient (xDrive) ²	kg	1100/1100 [1100/1100]	1300/1300 [1300/1300]	[1300/1300]	-	-	1300/1300 [1300/1300]	1300/1300 [1300/1300]	[1300/1300] [(1500/1500)]
Luggage capacity	l	380-1200	380-1200	380-1200	380-1200	380-1200	380-1200	380-1200	380-1200

BMW TwinPower Turbo engine ³									
Cylinders/valves		3/4	3/4	4/4	4/4	4/4	3/4	4/4	4/4
Capacity	cm ³	1499	1499	1998	1998	1998	1496	1995	1995
Max. output/engine speed	kW (hp)/ rpm	80 (109)/ 4300-6500	100 (136)/ 4500-6500	131 (178) ⁴ / 5000-5500	195 (265)/ 4750-6500	225 (306)/ 5000-6250	85 (116)/ 4000	110-100 (150-136)/ 4000	140 (190)/ 4000
Max. torque/engine speed	Nm/rpm	190/ 1380-3800	220/ 1500-4100	280/ 1350-4200	400/ 1750-4500	450/ 1800-4500	270/ 1750-2250	350/ 1750-2500	400/ 1750-2500

Power transmission									
Type of drive (xDrive)		Front-wheel	Front-wheel	Front-wheel	Front-wheel	(all-wheel)	Front-wheel	Front-wheel	Front-wheel (all-wheel)
Standard transmission (xDrive)		6-speed manual	6-speed manual	7-speed Steptronic with double clutch	8-speed Steptronic	(8-speed Steptronic Sport)	6-speed manual	6-speed manual	8-speed Steptronic (8-speed Steptronic)

Driving performance									
Top speed (xDrive)	km/h	200 [200]	213 [213]	[235]	[250] ⁵	[(250)] ⁵	200 [200]	218-211 [216]	[231] [(230)]
Acceleration 0-100 km/h (xDrive)	s	10.6 [10.6]	8.9 [8.8]	[7.0]	[6.1]	[(4.7-4.8)]	10.3 [10.1]	8.5-9.3 [8.4]	[7.3] [(7.0)]

Consumption ^{3,4} - All engines conform to the EU6 standard									
Combined (xDrive)	l/100 km	5.7-6.6 [5.8-6.8]	5.7-6.6 [5.6-6.6]	[6.0-6.9]	[6.9-7.5]	[(7.3-7.8)]	4.5-5.3 [4.6-5.3]	4.7-5.4 [4.9-5.6]	[4.9-5.7] [(5.3-5.9)]
Exhaust emissions standard (type-certified)		EU6d	EU6d	EU6d	EU6d	EU6d	EU6d	EU6d	EU6d
Combined CO ₂ emissions (xDrive)	g/km	129-151 [132-155]	129-151 [129-151]	[137-157]	[157-170]	[(167-178)]	118-139 [119-139]	122-142 [128-148]	[129-148] [(138-155)]
Tank capacity, approx.	l	42	42	50	50	50	42	42	50

Wheels/tyres									
Tyre dimensions		205/55 R16 W	205/55 R16 W	225/45 R17 Y	225/40 R18 Y	225/40 R18 Y	205/55 R16 W	205/55 R16 W	225/45 R17 Y
Wheel size		7J x 16	7J x 16	7.5J x 17	8J x 18	8J x 18	7J x 16	7J x 16	7.5J x 17
Material		Light alloy	Light alloy	Light alloy	Light alloy	Light alloy	Light alloy	Light alloy	Light alloy

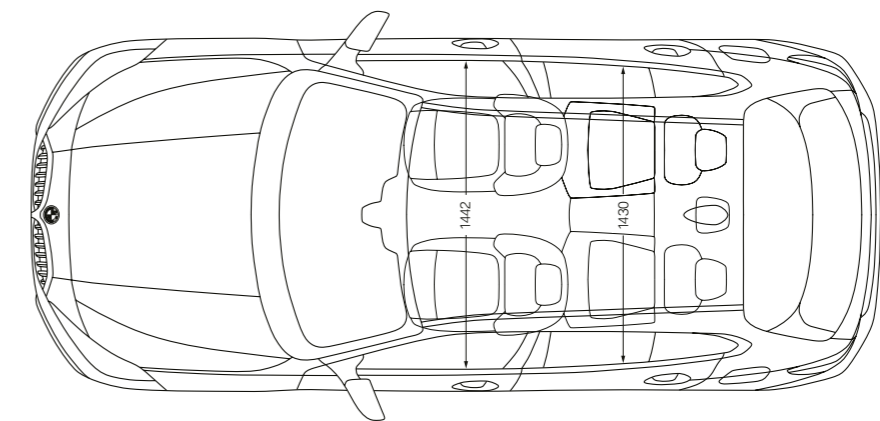
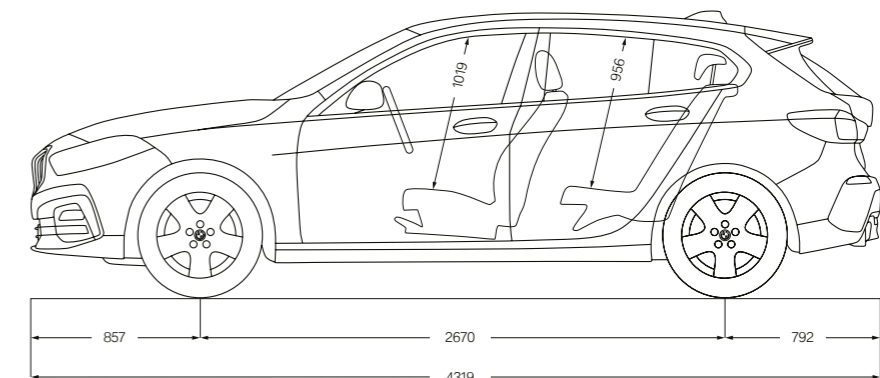
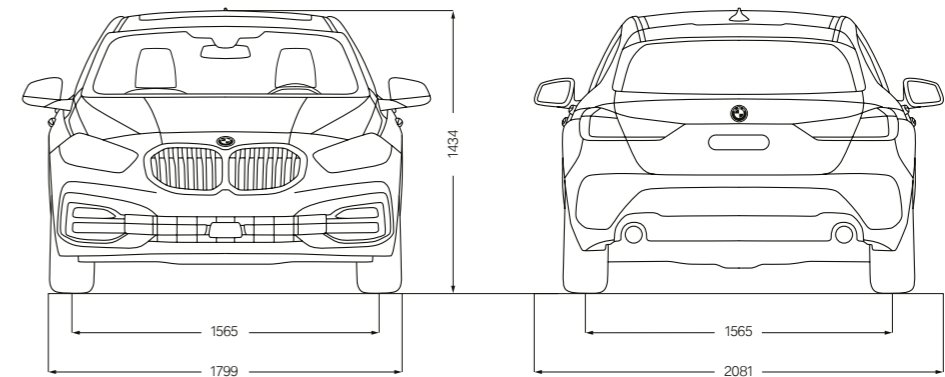

The figures for performance, fuel consumption and CO₂ emissions refer to vehicles with standard transmission. Figures in [] are for vehicles with Steptronic transmission.

¹ The EC unladen weight refers to a vehicle with standard equipment and does not include any optional extras. The unladen weight includes a 90% full tank and a driver weight of 75 kg. Optional equipment may affect the weight of the vehicle, the payload and the top speed if the selected equipment has an impact on the vehicle's aerodynamics.

² The actual total weight of the trailer must not exceed the maximum permitted trailer load, taking into account the maximum tow bar download.

³ Performance data of petrol engines apply to vehicles using RON 98 fuel. Fuel consumption data apply to vehicles using reference fuels in accordance with EU Regulation 2007/715. Unleaded RON 91 and higher with a maximum ethanol content of 10% (E10) may also be used. BMW recommends RON 95 super unleaded petrol.

⁴ The data for fuel consumption, CO₂ emissions and energy consumption are determined in accordance with the measurements processes as defined by European Regulation (EU) 715/2007 in the applicable version. Data refer to a vehicle with base-level equipment in Germany, and the ranges account for differences according to the selected wheel and tyre size and the optional equipment. For these vehicles, values other than those specified here may apply for the assessment of taxes and other vehicle-related charges that are (also) based on CO₂ emissions. Version 01/04/2021

⁵ Electronically limited.

⁶ Depending on the environmental conditions, a temporary peak performance is provided, which can be approx. 10% higher than the rated output. Peak performance duration increases with decreasing ambient temperature (at +25°C approx. 5 s, at -20°C approx. 40 s).



YOUR NEW SPEED DATING APP.

DOWNLOAD NOW THE BMW BROCHURES APP FROM YOUR APP STORE AND DISCOVER DRIVING PLEASURE!

BMW M135i xDrive:

BMW TwinPower Turbo 4-cylinder petrol engine, 225 kW (306 hp), 19" M light alloy wheels V-spoke style 557 M Cerium Grey matt, gloss-lathed, exterior colour in M Misano Blue metallic, M Sport seats in cloth 'Trigon'/Alcantara Black, 'Illuminated Boston' interior trim.

The models illustrated in this medium show the equipment and configuration options (standard and optional) for vehicles produced by BMW AG for the German market. Alterations in standard and optional equipment and the configurations available for the different models, as described in this medium, may occur after 11/11/2020, the editorial deadline for this medium, or according to the specific requirements of other member states of the European Union. Your local BMW Partner is available to provide further details. Subject to change in design and equipment.

Of course, each vehicle is designed for economical recycling after its long-running life. You can find more information regarding your end-of-life vehicle on our website www.bmw.de/recycling
© BMW AG, Munich, Germany. Not to be reproduced wholly or in part without prior written permission of BMW AG, Munich.